

Your choice of framed opening sizes & locations.

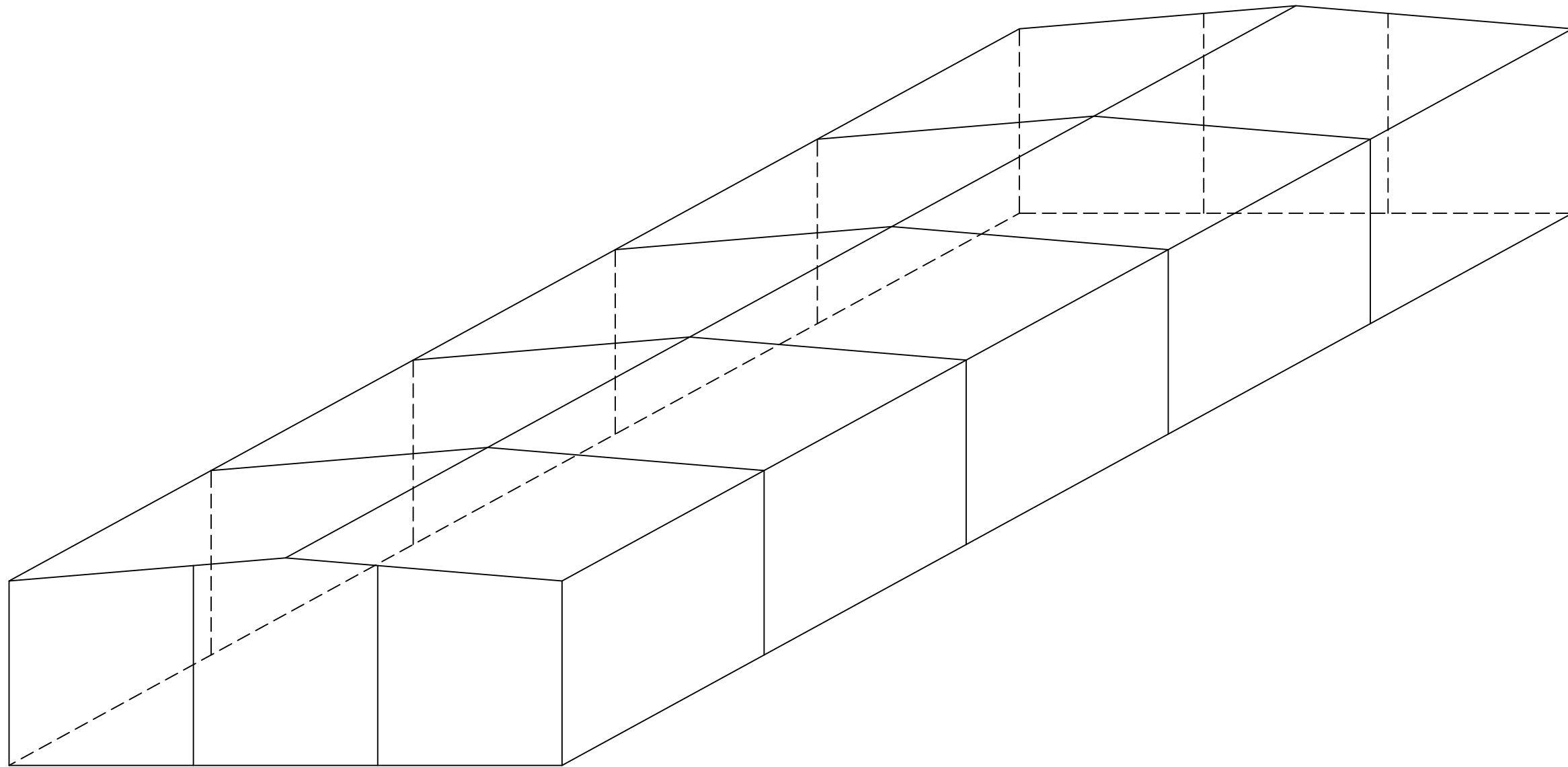

NOT FOR CONSTRUCTION

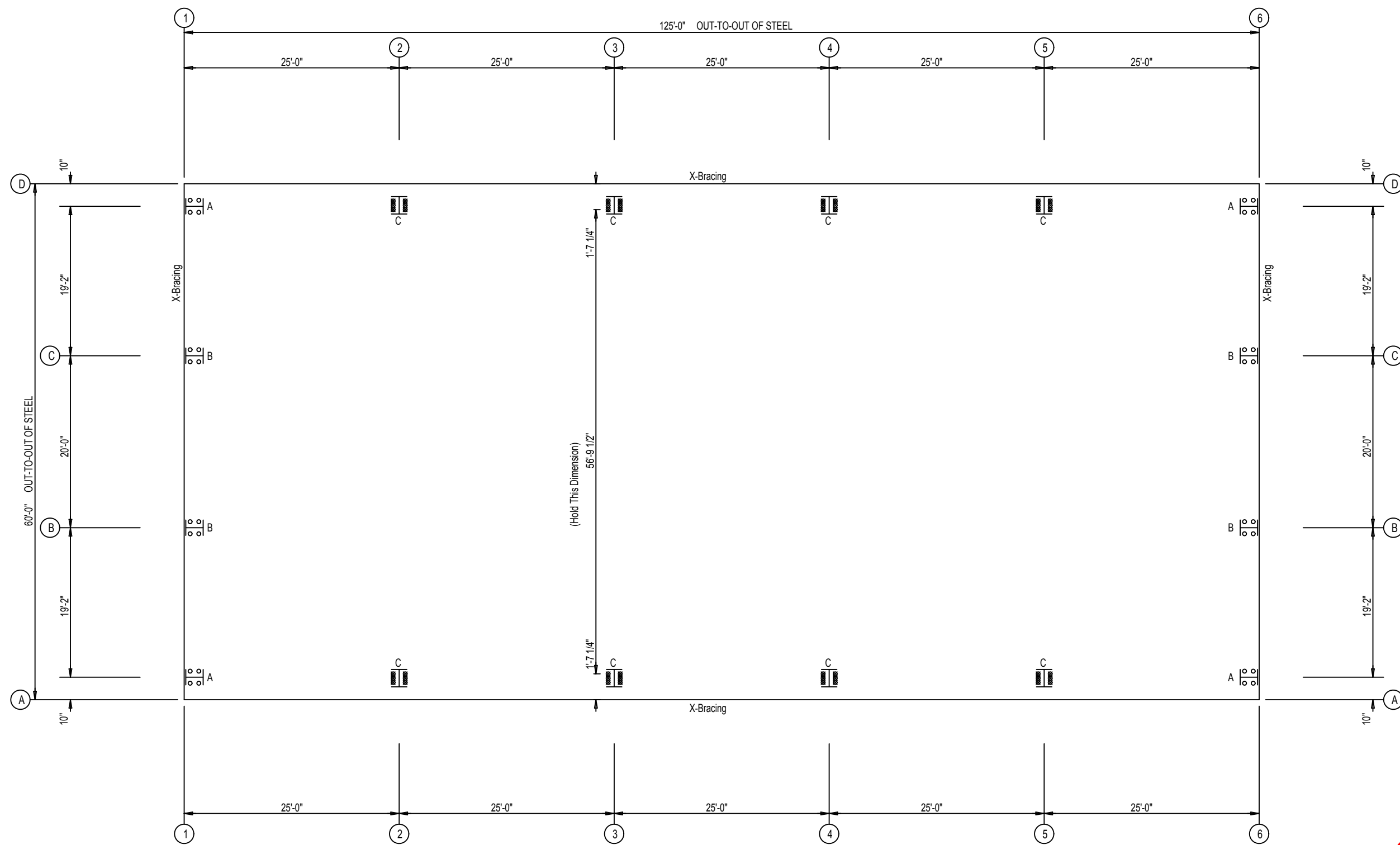

ANCHOR BOLT PLAN

NOT FOR CONSTRUCTION

SPECIAL BOLTS					
ROOF PLAN					
ID	QUAN	TYPE	DIA	LENGTH	WASH
1	2	A325	1/2"	1 1/4"	2

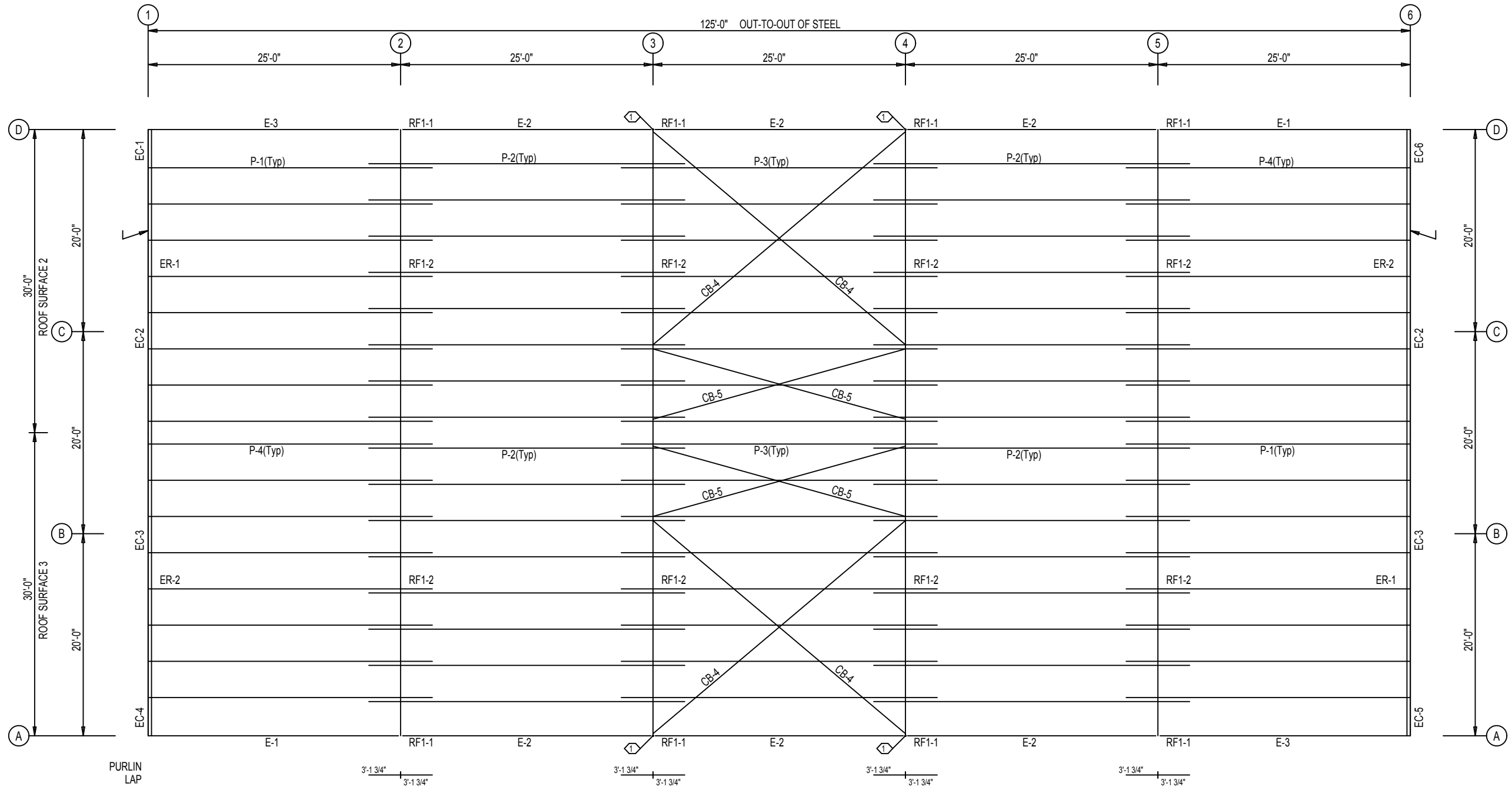

ROOF FRAMING PLAN

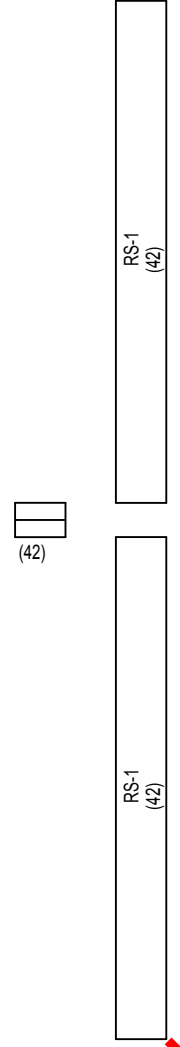

ROOF SHEETING
 PANELS: 26 Gauge PBR Galvalume

NOT FOR CONSTRUCTION

SPECIAL BOLTS					
ROOF PLAN					
ID	QUAN	TYPE	DIA	LENGTH	WASH
1	2	A325	1/2"	1 1/4"	2

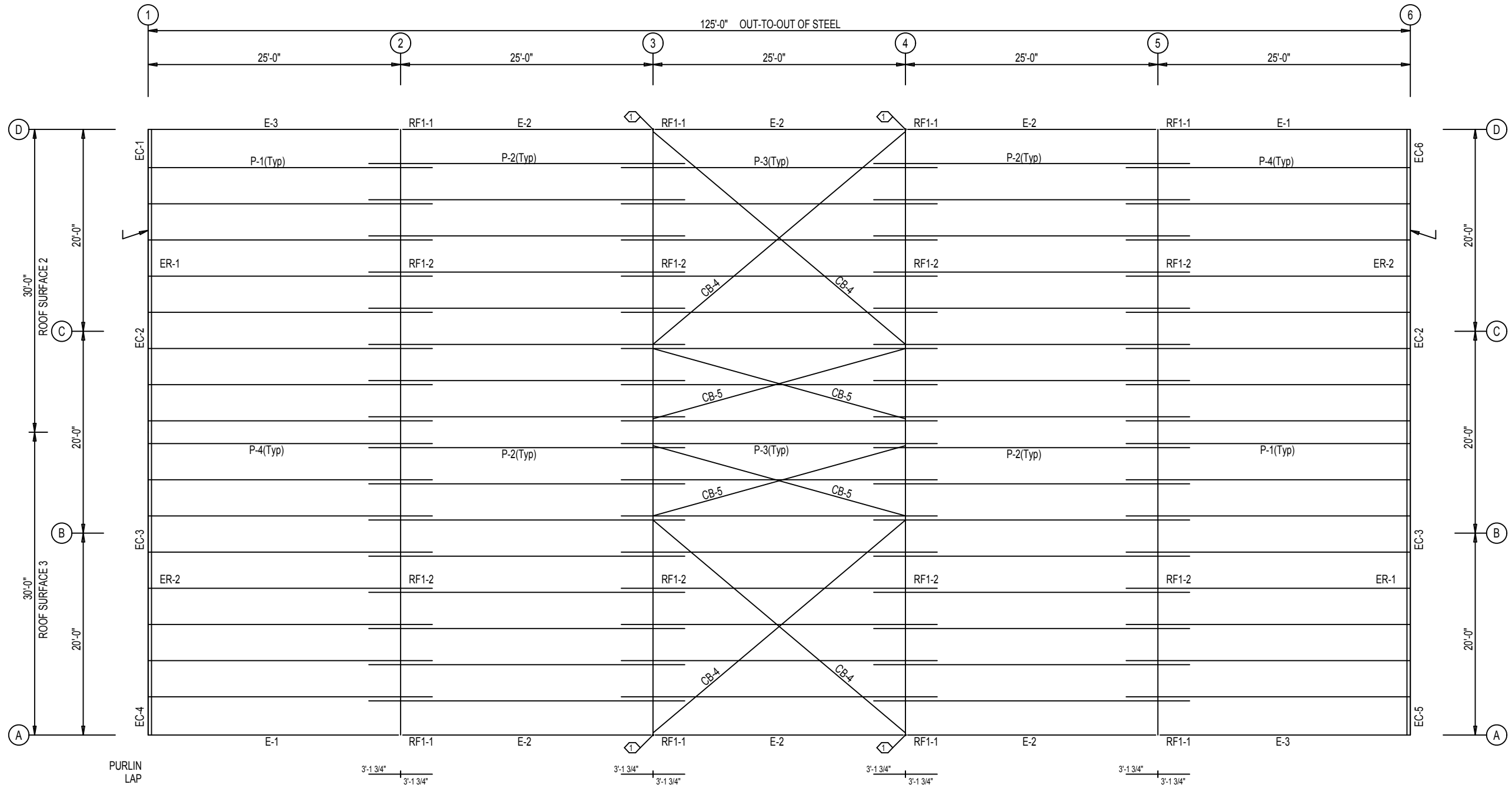

ROOF FRAMING PLAN

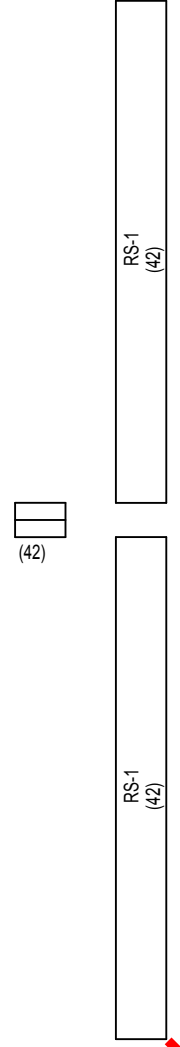

ROOF SHEETING
 PANELS: 26 Gauge PBR Galvalume

NOT FOR CONSTRUCTION

SPECIAL BOLTS					
ID	QUAN	TYPE	DIA	LENGTH	WASH
2	2	A325	1/2"	1 1/4"	2

CONNECTION PLATES	
FRAME LINE A	
ID	MARK/PART
1	SC-5

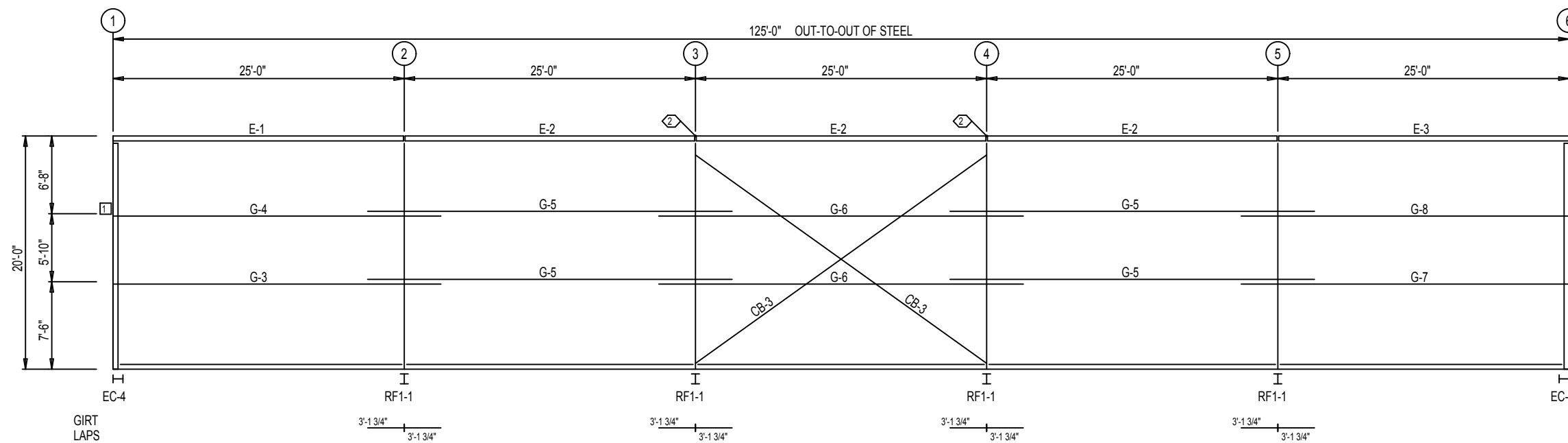

SIDEWALL FRAMING: FRAME LINE A

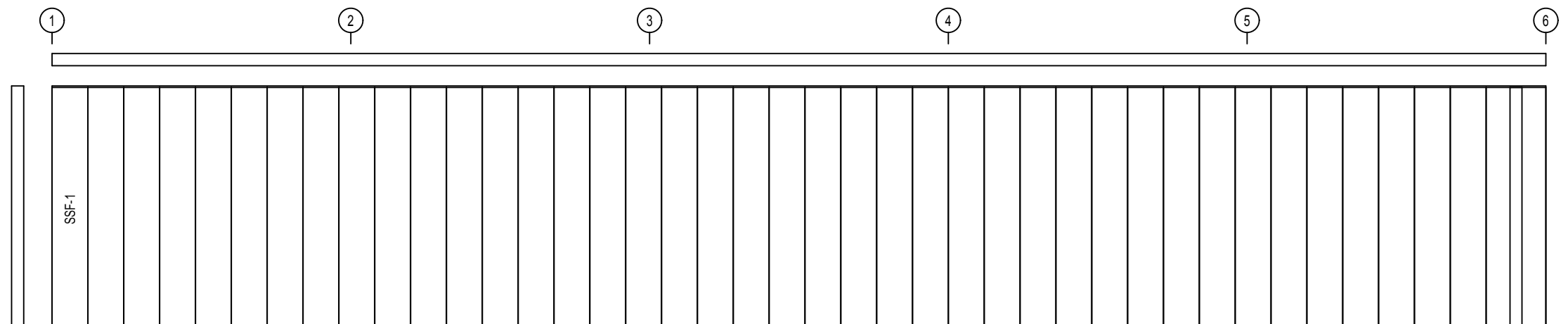

SIDEWALL SHEETING & TRIM: FRAME LINE A

PANELS: 26 Gauge PBR - Polar White

NOT FOR CONSTRUCTION

SPECIAL BOLTS					
ID	QUAN	TYPE	DIA	LENGTH	WASH
2	2	A325	1/2"	1 1/4"	2

CONNECTION PLATES	
FRAME LINE D	
ID	MARK/PART
1	SC-5

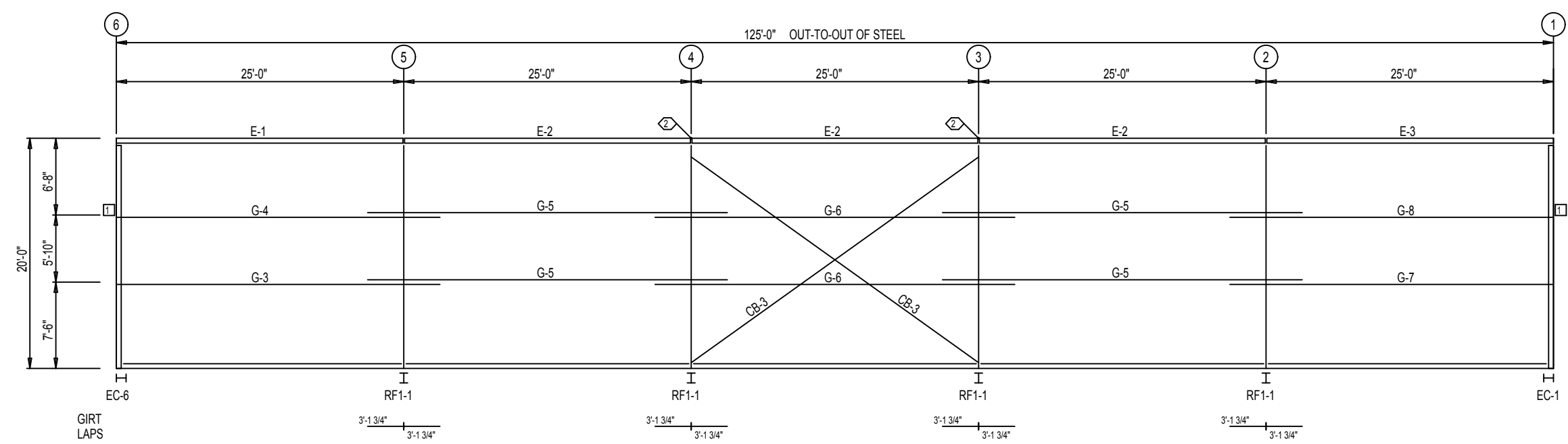

SIDEWALL FRAMING: FRAME LINE D

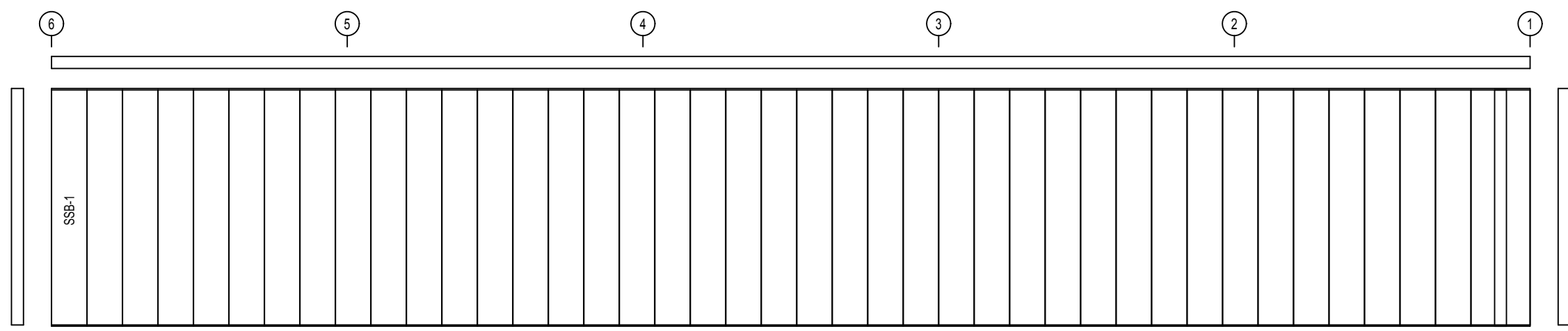

SIDEWALL SHEETING & TRIM: FRAME LINE D

PANELS: 26 Gauge PBR - Polar White

NOT FOR CONSTRUCTION

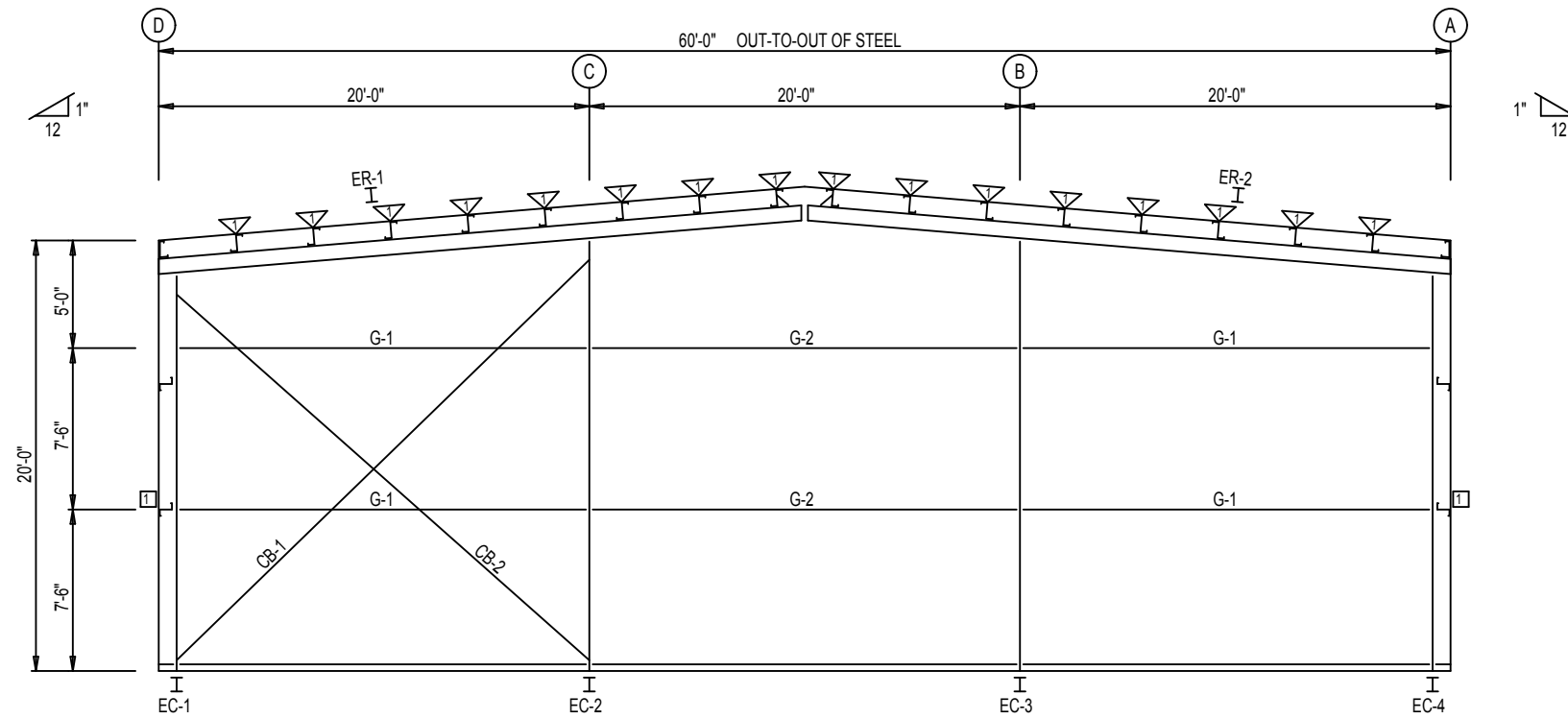

ENDWALL FRAMING: FRAME LINE 1

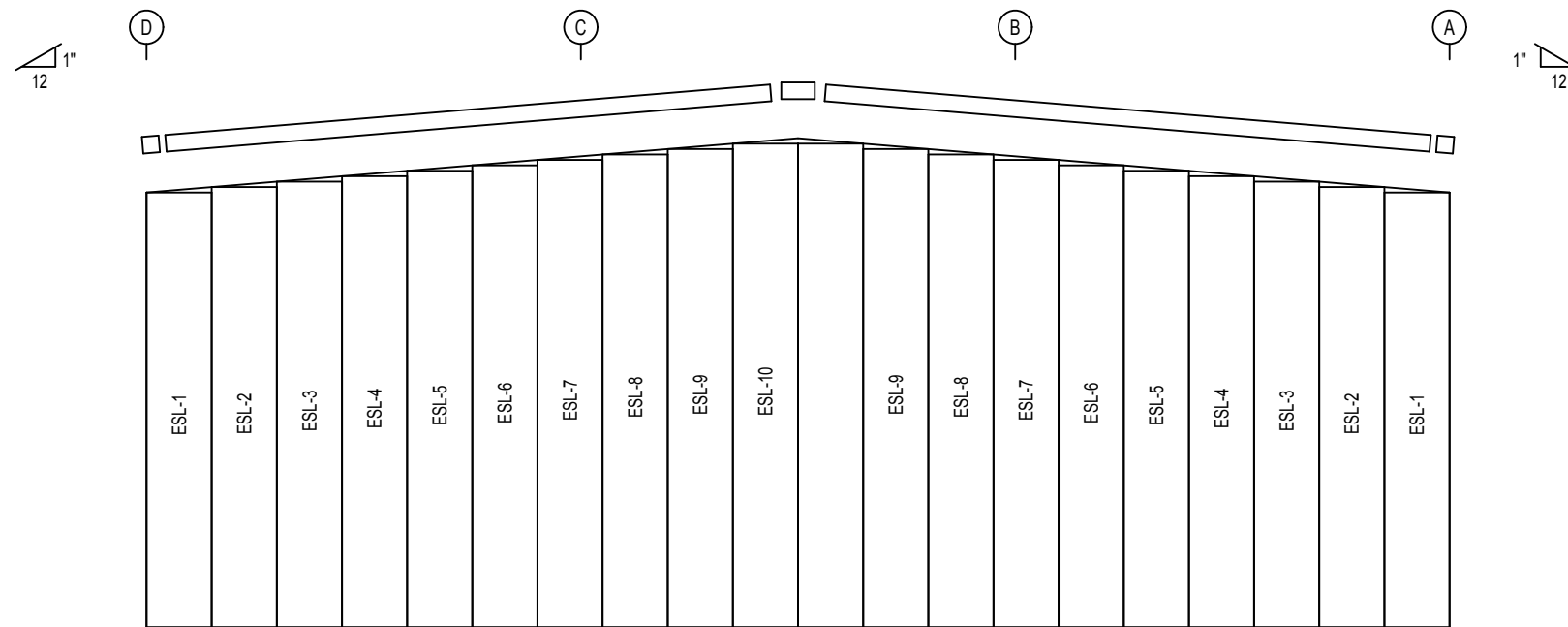

ENDWALL SHEETING & TRIM: FRAME LINE 1

PANELS: 26 Gauge PBR - Polar White

BOLT TABLE				
FRAME LINE 1				
LOCATION	QUAN	TYPE	DIA	LENGTH
ER-1/ER-2	8	A325	5/8"	1 3/4"
Columns/Raf	4	A325	1/2"	1 1/4"

FLANGE BRACE TABLE		
FRAME LINE 1		
▽ ID	PART	LENGTH
FB31	L2X2X14G	2'-7"

CONNECTION PLATES	
FRAME LINE 1	
□ ID	MARK/PART
1	SC-5

NOT FOR CONSTRUCTION

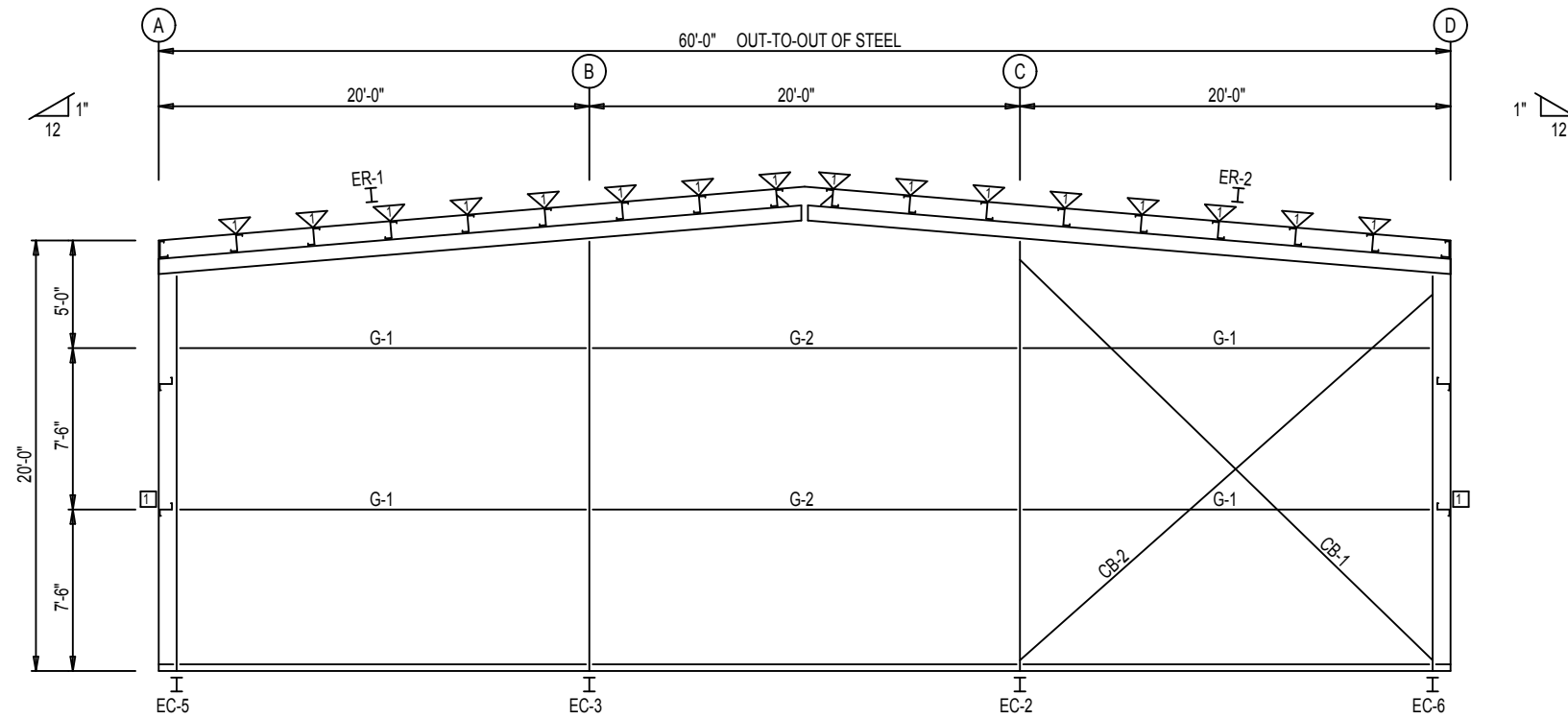

ENDWALL FRAMING: FRAME LINE 6

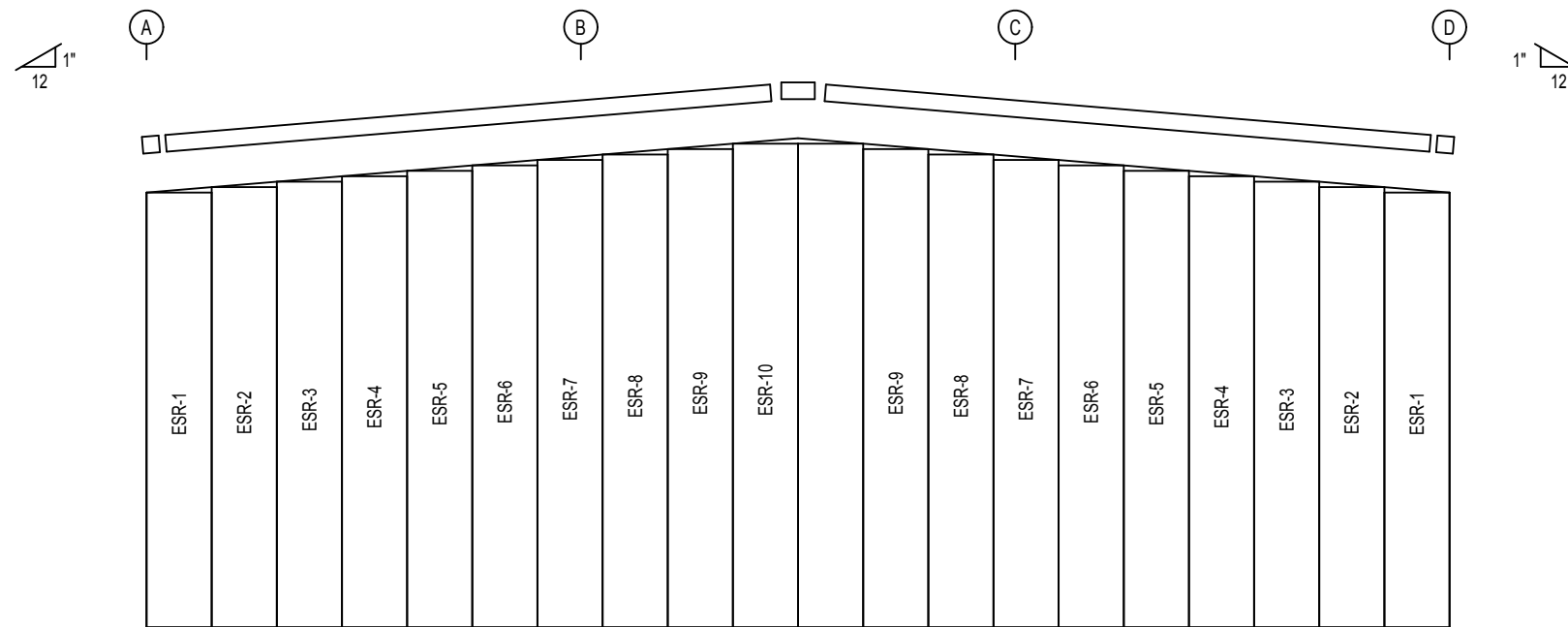

ENDWALL SHEETING & TRIM: FRAME LINE 6

PANELS: 26 Gauge PBR - Polar White

BOLT TABLE				
FRAME LINE 6				
LOCATION	QUAN	TYPE	DIA	LENGTH
ER-1/ER-2	8	A325	5/8"	1 3/4"
Columns/Raf	4	A325	1/2"	1 1/4"

FLANGE BRACE TABLE		
FRAME LINE 6		
▽ ID	PART	LENGTH
FB31	L2X2X14G	2'-7"

CONNECTION PLATES	
FRAME LINE 6	
□ ID	MARK/PART
1	SC-5

NOT FOR CONSTRUCTION

STIFFENER TABLE				
Mark	Stiffener Mark	Width	Plate Size Thick	Length
RF1-1	St-1	4"	1/4"	34"

FLANGE BRACES: BOTH SIDES (UNLESS NOTED)
 FBxxC(1): xx=length
 C - L2X2X1/8
 A - L2X2X1/4G

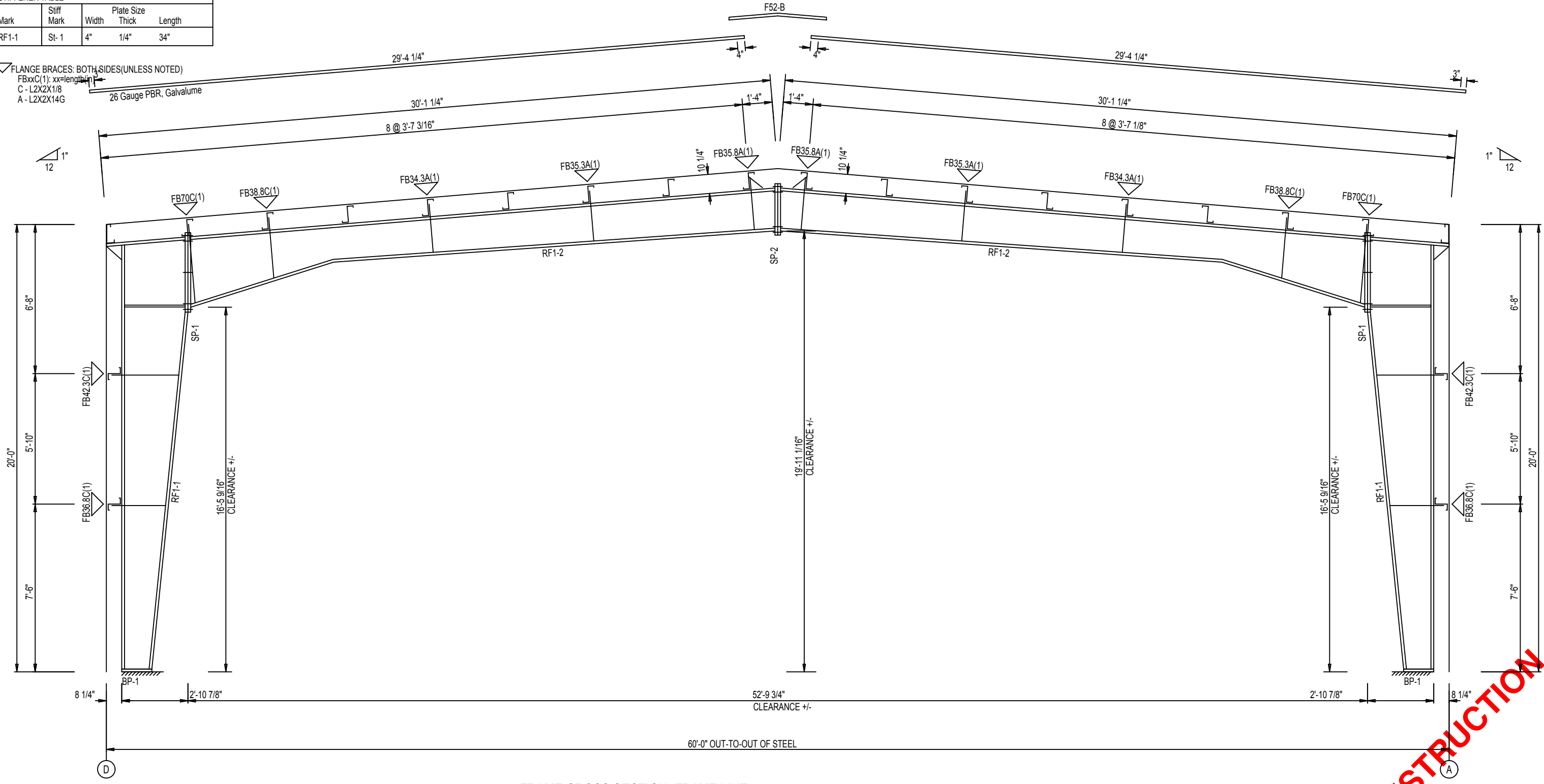

FRAME CROSS SECTION: FRAME LINE 2 3 4 5

NOT FOR CONSTRUCTION