

REAR ELEVATION

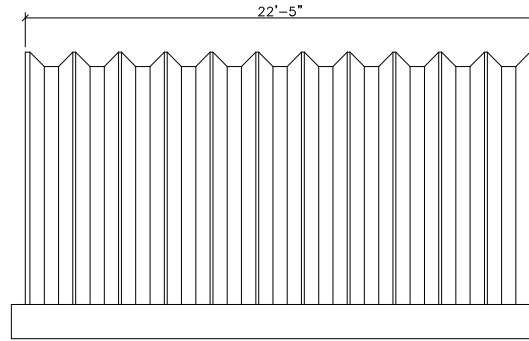

SIDE ELEVATION

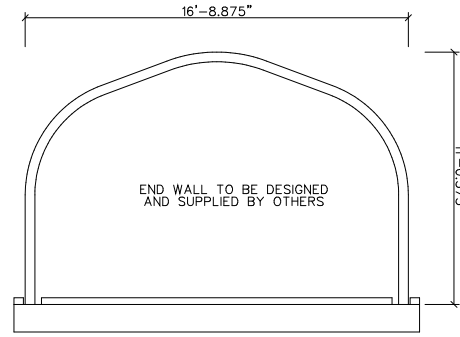

FRONT ELEVATION

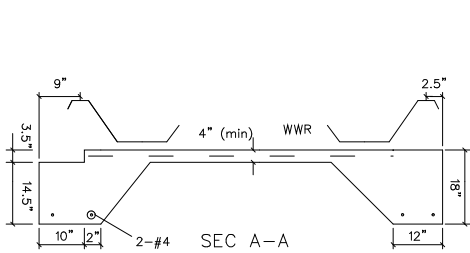

SEC A-A

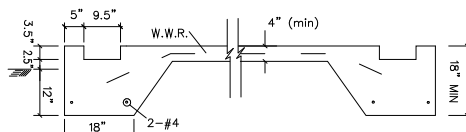

SEC B-B

WARNING: DO NOT REMOVE OR REDUCE THE CONCRETE FLOOR OR THE REINFORCING STEEL, AND/OR RAISE THE TOPS OF THE FOOTERS ABOVE THE FLOOR OR BUILDING FAILURE MAY RESULT

- Minimum Concrete Cover:
- (a) Concrete Cast against earth: 3"
  - (b) Concrete exposed to earth or weather: 2"
  - No. 6 through No. 10 bars: 1.5"
  - No. 5 bar and smaller: 0.75"
  - (c) Concrete not exposed to earth or weather: 0.75"

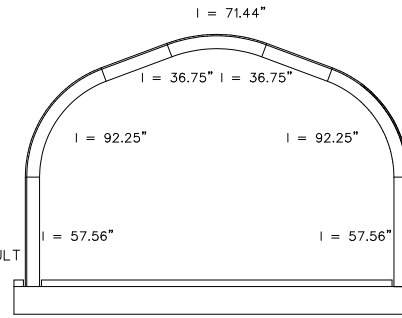

ARCH PROFILE

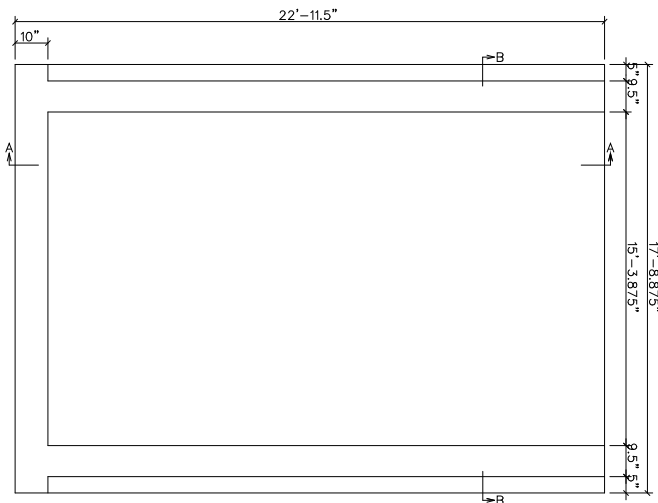

FOUNDATION PLAN

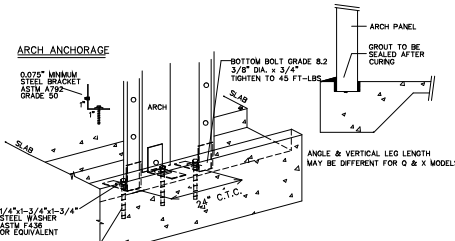

MULTI RIB-ZE ANCHORS (CC-ESR-3027) OR EQUIVALENT:  
 1/2" DIA. x 4 1/2" BOLTS WITH 4 1/4" EMBEDDED DEPTH FOR BUILDINGS LESS THAN 30'-0" WIDE  
 5/8" DIA. x 5 1/2" BOLTS WITH 5 1/4" EMBEDDED DEPTH FOR 30'-0" WIDE AND GREATER

FIRST ANCHOR BOLT LOCATION:  
 • 2.5" WITH NO WALL OR MANUFACTURER'S CLASSED ENDWALL  
 • 3.5" WITH MANUFACTURER'S CORRUGATED ENDWALL  
 ARCHES AND MANUFACTURER'S ENDWALLS MUST BE GROUDED INTO FOUNDATION ON BOTH SIDES OF PANELS.

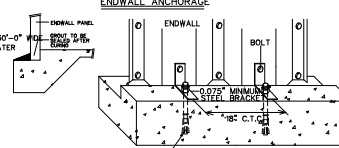

FIRST ANCHOR BOLT LOCATION:  
 • SOLID ENDWALL = 5" FROM BUILDING CENTERLINE+18" C.T.C.  
 • OPEN ENDWALL = 11" FROM OPENING+18" C.T.C.

- GENERAL NOTES
- ALL MATERIAL AND WORKMANSHIP SHALL CONFORM WITH THE REQUIREMENTS OF THE LATEST REVISION OF THE INTERNATIONAL BUILDING CODE 2006. DESIGN ACCORDING TO NASPC-01, NORTH AMERICAN SPECIFICATION FOR THE DESIGN OF COLD-FORMED STEEL STRUCTURAL MEMBERS, AND WITH ANSI/ASCE 7-05.
  - NO LOADS OTHER THAN THOSE GIVEN UNDER "DESIGN DATA" BELOW SHALL BE IMPOSED ON THE "STRUCTURE"
  - SPECIFIC NOTES AND DETAILS SHOWN ON THE DRAWINGS SHALL TAKE PRECEDENCE OVER THE BUILDING MANUAL SUPPLIED.
  - THE BUILDING, INCLUDING THE FOUNDATION, MUST BE CONSTRUCTED IN STRICT ACCORDANCE WITH THE DRAWING AND ERECTION INSTRUCTIONS. ANY DEVIATION UNLESS APPROVED BY US IN WRITING, SHALL NULLIFY OUR CERTIFICATE AND SEAL AND SHALL BE THE SOLE RESPONSIBILITY OF THE ERECTOR.
  - A PROFESSIONAL ENGINEER SHOULD BE RETAINED WHERE SITE INSPECTIONS ARE WARRANTED.
  - NO ARCH PANEL MAY BE CUT OR MODIFIED UNLESS IT IS TO ACCOMMODATE AN ACCESSORY PROVIDED BY THE MANUFACTURER IN ACCORDANCE WITH ITS INSTRUCTIONS AND/OR THIS DRAWING.
  - MINIMUM SEPARATION FROM THIS BUILDING TO ANY TALLER BUILDING MUST BE THE SMALLER OF 20 FEET AND 8 TIMES THE HEIGHT DIFFERENCE.
- FOUNDATION NOTES
- NOTE: THE FOUNDATION ON THE DRAWING SPECIFIES THE MINIMUM REQUIREMENTS. LOCAL BUILDING CODE AND SITE CONDITIONS MAY REQUIRE A STRONGER FOUNDATION, WHICH MUST BE DESIGNED BY A LOCAL ENGINEER.
- THE FOUNDATION SHALL BE FOUNDED ON NATURAL UNDISTURBED SOIL, CAPABLE OF SAFELY SUSTAINING 1500 psf. THIS SHALL BE DESIGNED TO FULLY RESIST ALL ROTATION AT THE BASE OF THE ARCH.
  - SLAB ON GRADE SHALL BE PLACED ON WELL COMPACTED SOIL, CAPABLE OF SUSTAINING 1500 psf WITHOUT APPRECIABLE SETTLEMENT.

- DESIGN DATA (MATERIALS)
- CONCRETE  $f'_c = 2500$  PSI @ 28 DAYS, ACI
  - REINFORCING STEEL GRADE 40,  $F_y = 40$  KSI, ASTM A615
  - W.W.R.  $F_y = 65$  KSI, ASTM A185
  - W.W.R. 6 x 6 - W14 x W14

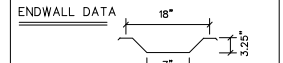
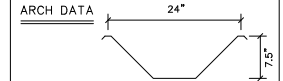

- BOLTS: SAE GRADE 2 OR ASTM A307  
 ARCH STEEL THICKNESS - SEE ARCH PROFILE  
 ENDWALL STEEL THICKNESS = 0.03 in.
- GALVALUME SHEET STEEL  
 STRUCTURAL QUALITY ASTM SPECIFICATION A792-03  
 50K ALUMINUM-ZINC ALLOY (HOT DIP COATING)  
 ASTM A792 GRADE 50A  
 50 KSI MINIMUM YIELD  
 65 KSI MINIMUM TENSILE
- HSS SECTIONS SHALL CONFORM TO:  
 ASTM A500 GRADE B ( $F_y = 48$  ksi)  
 W SECTIONS SHALL CONFORM TO:  
 ASTM A992 GRADE 50 ( $F_y = 50$  ksi)  
 OTHER SECTIONS SHALL CONFORM TO:  
 ASTM A36 ( $F_y = 36$  ksi)

- ARCH DESIGN DATA IN ACCORDANCE WITH ANSI/ASCE 7-05:
- ROOF LIVE LOAD (PSF) = 0  
 Pg GROUND SNOW LOAD (PSF) = 0  
 Ce EXPOSURE FACTOR = 1.0  
 Ct THERMAL FACTOR = 1.0  
 Importance Factor (SNOW) = 0.8  
 CATEGORY I/AGRICULTURAL BUILDING  
 Pnet COMPONENT WIND PRESSURE (PSF) = +/- 0  
 V : BASIC WIND SPEED (MPH) = 0  
 Kh VELOCITY PRESSURE EXPOSURE = 0.85  
 Importance Factor (WIND) = 0.87  
 AND GUST-EFFECT FACTOR = +/- 0.16  
 Kzt WIND DIRECTIONALITY FACTOR = 0.85  
 Kzt1 TOPOGRAPHIC FACTOR = 1.0  
 I : IMPORTANCE FACTOR (WIND) = 0.87  
 WIND EXPOSURE CATEGORY = C  
 SEISMIC DESIGN CATEGORY = D2

LEGAL NOTE  
 This drawing is the property of Future Steel Buildings Intl. Corp. Any duplication of this drawing in whole or in part is strictly forbidden. Anyone doing so will be prosecuted under the full extent of the law.

REVISIONS:	
DATE:	
BY:	
CHECKED BY:	
DATE:	
PROJECT:	
SCALE:	N.T.S.
APPROVED BY:	
DATE:	10/27/2007
PROJECT:	
MODEL:	AT7-11

ENTRUSTED SEAL:

Future Steel Buildings Intl. Corp.  
 220 Chrysler Drive, Brampton, Ontario, Canada, L6S 6B6, Phone: (905) 790-8500